

# Inductive sensor

## NMB10-18GM65-Z4-V1



- 10 mm flush
- Stainless steel sensing face
- Increased operating distance



### Dimensions

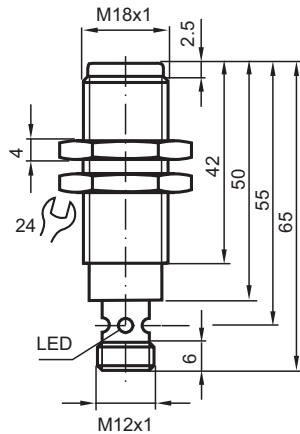

### Technical Data

#### General specifications

Switching function		Normally open (NO)
Output type		Two-wire
Rated operating distance	$s_n$	10 mm
Installation		flush (Requirements: see drawing below)
Output polarity		DC
Assured operating distance	$s_a$	0 ... 8.1 mm
Actuating element		Ferrous and nonferrous targets
Reduction factor $r_{Al}$		0.4
Reduction factor $r_{Cu}$		0.25
Reduction factor $r_{304}$		0.85
Reduction factor $r_{St37}$		1
Output type		2-wire
<b>Nominal ratings</b>		
Operating voltage	$U_B$	6 ... 30 V DC

Release date: 2022-06-30 Date of issue: 2022-06-30 Filename: 912736\_eng.pdf

Refer to "General Notes Relating to Pepperl+Fuchs Product Information".

Pepperl+Fuchs Group  
www.pepperl-fuchs.com

USA: +1 330 486 0001  
fa-info@us.pepperl-fuchs.com

Germany: +49 621 776 1111  
fa-info@de.pepperl-fuchs.com

Singapore: +65 6779 9091  
fa-info@sg.pepperl-fuchs.com

**PF** PEPPERL+FUCHS

## Technical Data

Switching frequency	f	200 Hz
Hysteresis	H	5 ... 15 typ. 10 %
Reverse polarity protection		reverse polarity-conductive
Short-circuit protection		pulsing
Voltage drop	$U_d$	< 3 V
Operating current	$I_L$	2 ... 200 mA
Off-state current	$I_r$	≤ 400 μA
Switching state indicator		LED, yellow

### Compliance with standards and directives

Standard conformity		
Standards		EN 60947-5-2:2007 EN 60947-5-2/A1:2012 IEC 60947-5-2:2007 IEC 60947-5-2 AMD 1:2012

### Approvals and certificates

UL approval		cULus Listed, General Purpose
CSA approval		cCSAus Listed, General Purpose
CCC approval		CCC approval / marking not required for products rated ≤36 V

### Ambient conditions

Ambient temperature		-25 ... 70 °C (-13 ... 158 °F)
---------------------	--	--------------------------------

### Mechanical specifications

Connection type		Connector plug M12 x 1 , 4-pin
Housing material		Stainless steel 1.4305 / AISI 303
Sensing face		Stainless steel 1.4305 / AISI 303
Degree of protection		IP67

## Connection

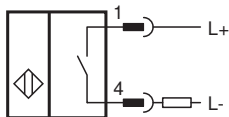

## Connection Assignment

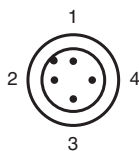

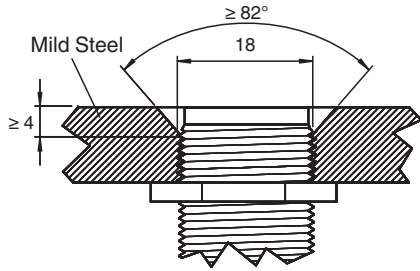

Release date: 2022-06-30 Date of issue: 2022-06-30 Filename: 912736\_eng.pdf

**Mounting**



Sensor face is flush with mounting surface.

**Accessories**

	<b>V1-G-2M-PUR</b>	Female cordset single-ended M12 straight A-coded, 4-pin, PUR cable grey
	<b>V1-W-2M-PUR</b>	Female cordset single-ended M12 angled A-coded, 4-pin, PUR cable grey
	<b>AB-18</b>	Mounting aid

Release date: 2022-06-30 Date of issue: 2022-06-30 Filename: 912736\_eng.pdf